

Procédures et fonctions

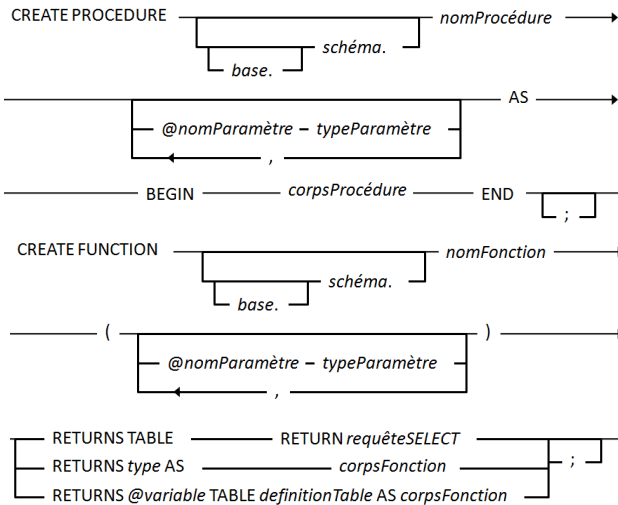

Les déclencheurs

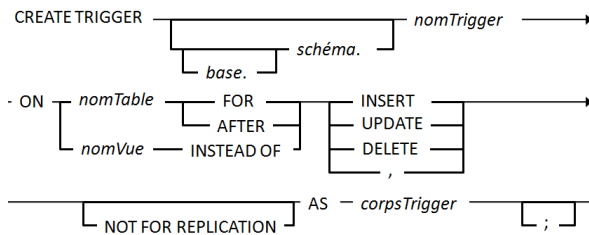

<http://www.apsql.com>

Information_schema

Vues, Procédures et fonctions	Contraintes d'intégrités
REFERENTIAL_CONSTRAINTS	TABLE_CONSTRAINTS
ROUTINES	CHECK_CONSTRAINTS
ROUTINE_COLUMNS	COLUMN_DOMAIN_USAGE
VIEWS	COLUMN_PRIVILEGES
PARAMETERS	CONSTRAINT_COLUMN_USAGE
VIEW_TABLE_USAGE	CONSTRAINT_TABLE_USAGE
VIEW_COLUMN_USAGE	DOMAIN_CONSTRAINTS
Schémas, tables et colonnes	DOMAINS
TABLES	KEY_COLUMN_USAGE
COLUMNS	
SCHEMATA	
TABLE_PRIVILEGES	

Variables systèmes

Configuration

[@@DATEFIRST](#)
[@@OPTIONS](#)
[@@DBTS](#)
[@@REMSERVER](#)
[@@LANGID](#)
[@@SERVERNAME](#)
[@@LANGUAGE](#)
[@@SERVICENAME](#)
[@@LOCK_TIMEOUT](#)
[@@SPID](#)
[@@MAX_CONNECTIONS](#)
[@@TEXTSIZE](#)
[@@MAX_PRECISION](#)
[@@VERSION](#)
[@@NESTLEVEL](#)

Curseur

[@@CURSOR_ROWS](#)
[@@FETCH_STATUS](#)

Statistiques

[@@CONNECTIONS](#)
[@@PACK_RECEIVED](#)
[@@CPU_BUSY](#)
[@@PACK_SENT](#)
[@@TIMETICKS](#)
[@@IDLE](#)
[@@TOTAL_ERRORS](#)
[@@IO_BUSY](#)
[@@TOTAL_READ](#)
[@@PACKET_ERRORS](#)
[@@TOTAL_WRITE](#)

Metadonnées

[@@PROCID](#)

Système

[@@ERROR](#)
[@@IDENTITY](#)
[@@ROWCOUNT](#)
[@@TRANCOUNT](#)

Aide mémoire

SQL Server 2008



APSQL

<http://www.apsql.com>

jerome@apsql.com

<http://www.apsql.com>

Modifier les données

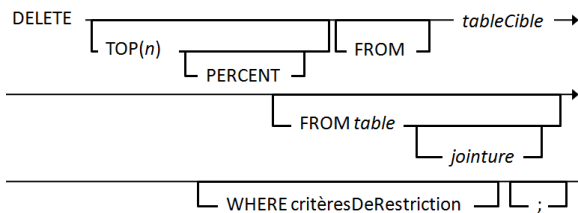
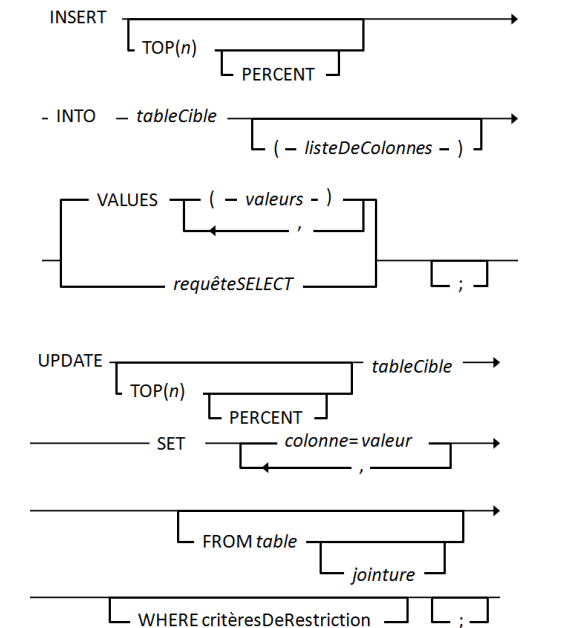

Les tables CTE

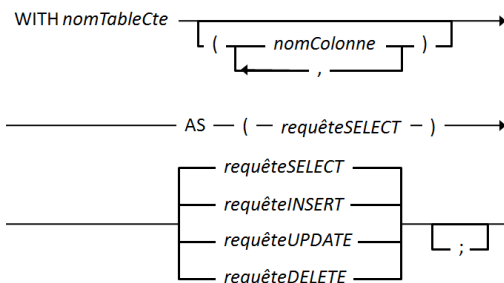

Travailler avec les données

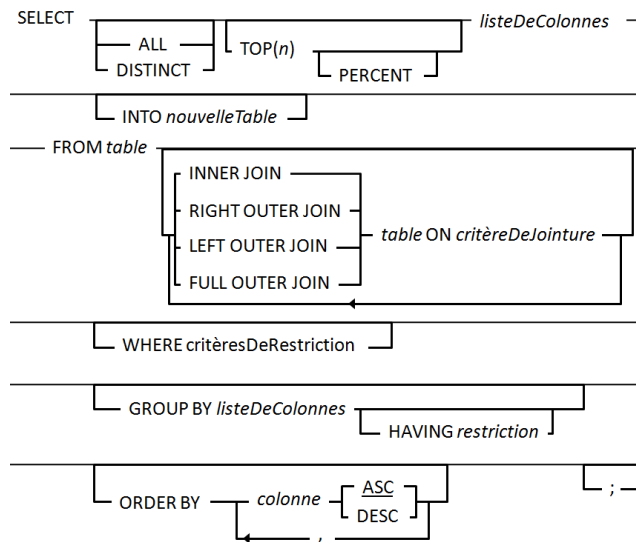

Créer une table

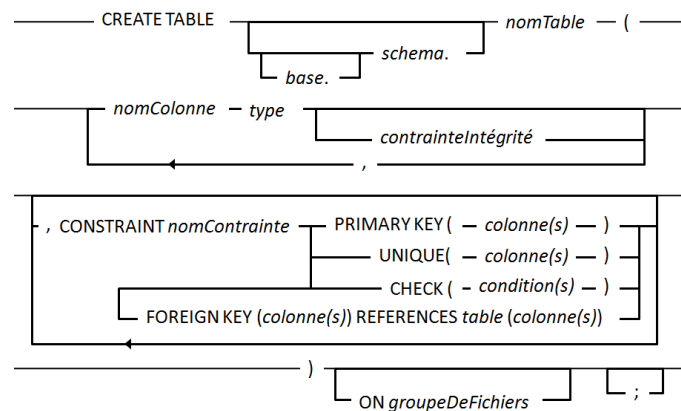

Modifier une table

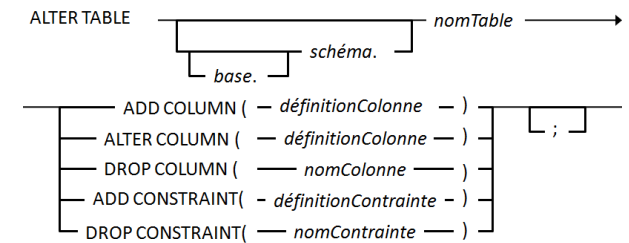

Types de données

Autres

binary (n)
 varbinary(n|max)
 bit
 hierarchyid
 timestamp
 uniqueidentifier
 xml

Caractères

char(n)
 nchar(n)
 varchar(n|max)
 nvarchar(n|max)

Monétaires

money
 smallmoney

Numériques

int
 bigint
 smallint
 tinyint
 decimal(p,s)
 numeric(p,s)
 real(n)
 float(n)

Date et heure

datetime
 datetime2(p)
 datetimeoffset(p)
 smalldatetime
 time
 date